

Silicon Schottky Diode

- General-purpose diode for high-speed switching
- Circuit protection
- Voltage clamping
- High-level detecting and mixing
- Pb-free (RoHS compliant) package
- Qualified according AEC Q101¹⁾

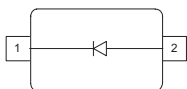

BAS140W
BAS40-02L



BAS40

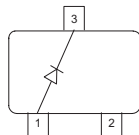

BAS40-04

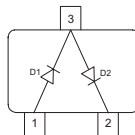

BAS40-05
BAS40-05W

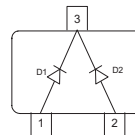

BAS40-06
BAS40-06W

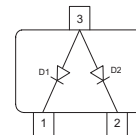

BAS40-07
BAS40-07W

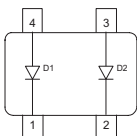

ESD (Electrostatic discharge) sensitive device, observe handling precaution!

Type	Package	Configuration	Marking
BAS140W	SOD323	single	white 4
BAS40	SOT23	single	43s
BAS40-02L*	TSLP-2-1	single, leadless	FF
BAS40-04	SOT23	series	44s
BAS40-05	SOT23	common cathode	45s
BAS40-05W	SOT323	common cathode	45s
BAS40-06	SOT23	common anode	46s
BAS40-06W	SOT323	common anode	46s
BAS40-07	SOT143	parallel pair	47s
BAS40-07W	SOT343	parallel pair	47s

¹⁾ BAS40-02L is not qualified according AEC Q101

Maximum Ratings at $T_A = 25\text{ °C}$, unless otherwise specified

Parameter	Symbol	Value	Unit
Diode reverse voltage	V_R	40	V
Forward current	I_F	120	mA
Non-repetitive peak surge forward current $t \leq 10\text{ms}$	I_{FSM}	200	
Total power dissipation BAS140W, $T_S \leq 113\text{°C}$ BAS40, BAS40-07, $T_S \leq 81\text{°C}$ BAS40-02L, $T_S \leq 127\text{°C}$ BAS40-04, BAS40-06, $T_S \leq 56\text{°C}$ BAS40-06W, $T_S \leq 106\text{°C}$ BAS40-05, $T_S \leq 31\text{°C}$ BAS40-05W, $T_S \leq 98\text{°C}$ BAS40-07W, $T_S \leq 118\text{°C}$	P_{tot}	250 250 250 250 250 250 250 250	mW
Junction temperature	T_j	150	
Operating temperature range	T_{op}	-55 ... 150	
Storage temperature	T_{stg}	-55 ... 150	

Thermal Resistance

Parameter	Symbol	Value	Unit
Junction - soldering point ¹⁾	R_{thJS}		K/W
BAS140W		≤ 150	
BAS40, BAS40-07		≤ 275	
BAS40-02L		≤ 90	
BAS40-04, BAS40-06		≤ 375	
BAS40-06W		≤ 175	
BAS40-05		≤ 475	
BAS40-05W		≤ 205	
BAS40-07W		≤ 125	

¹⁾For calculation of R_{thJA} please refer to Application Note AN077 (Thermal Resistance Calculation)

Electrical Characteristics at $T_A = 25^\circ\text{C}$, unless otherwise specified

Parameter	Symbol	Values			Unit
		min.	typ.	max.	
DC Characteristics					
Breakdown voltage $I_{(BR)} = 10 \mu\text{A}$	$V_{(BR)}$	40	-	-	V
Reverse current $V_R = 30 \text{ V}$	I_R	-	-	1	μA
Forward voltage $I_F = 1 \text{ mA}$ $I_F = 10 \text{ mA}$ $I_F = 40 \text{ mA}$	V_F	250 350 600	310 450 720	380 500 1000	mV
Forward voltage matching ¹⁾ $I_F = 10 \text{ mA}$	ΔV_F	-	-	20	
AC Characteristics					
Diode capacitance $V_R = 0, f = 1 \text{ MHz}$	C_T	-	3	5	pF
Differential forward resistance $I_F = 10 \text{ mA}, f = 10 \text{ kHz}$	R_F	-	10	-	Ω
Charge carrier life time $I_F = 25 \text{ mA}$	τ_{rr}	-	-	100	ps

¹⁾ ΔV_F is the difference between lowest and highest V_F in a multiple diode component.

Diode capacitance $C_T = f(V_R)$

$f = 1\text{MHz}$

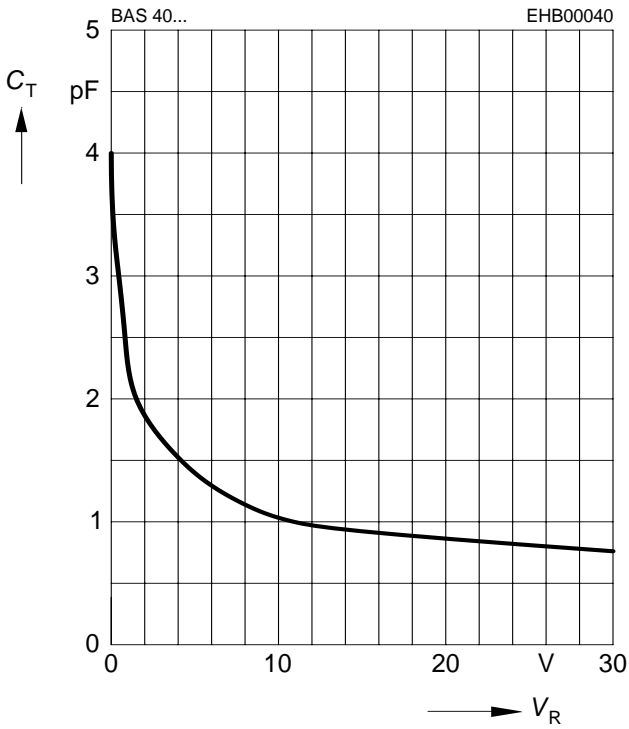

Forward resistance $r_f = f(I_F)$

$f = 10\text{kHz}$

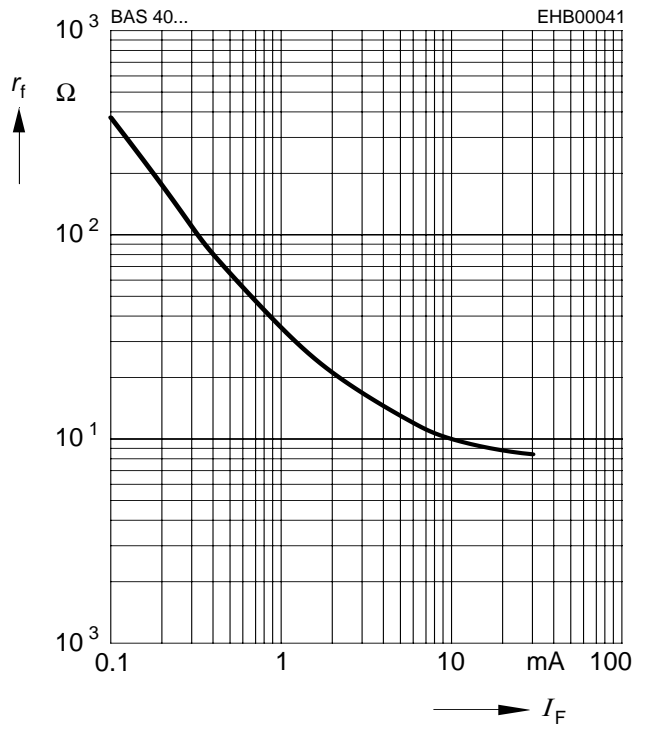

Reverse current $I_R = f(T_A)$

$V_R = \text{Parameter}$

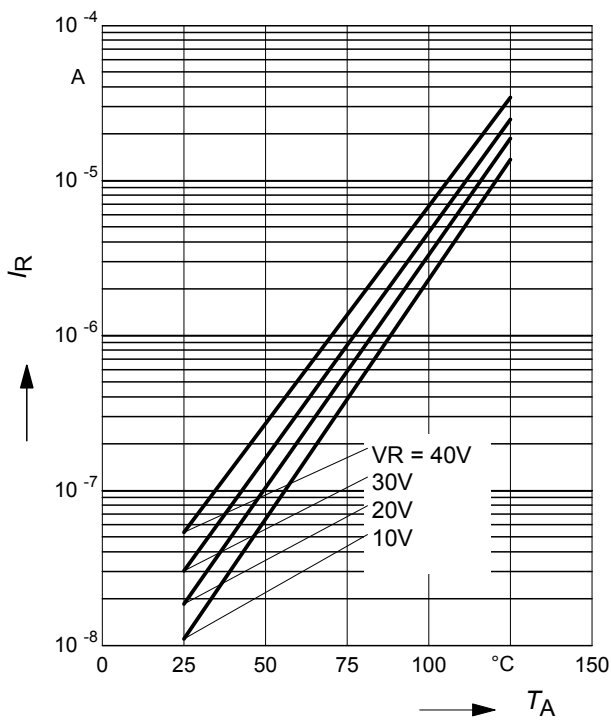

Reverse current $I_R = f(V_R)$

$T_A = \text{Parameter}$

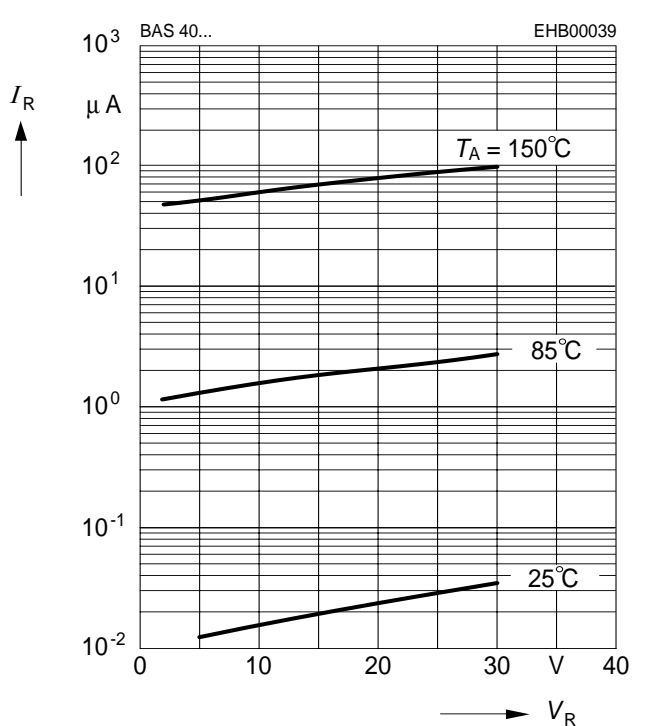

Forward Voltage $V_F = f(T_A)$

$I_F = \text{Parameter}$

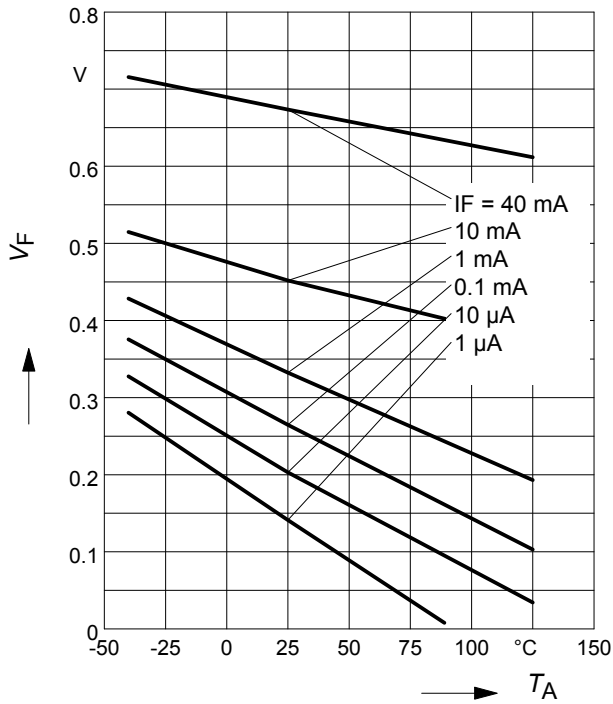

Forward current $I_F = f(V_F)$

$T_A = \text{Parameter}$

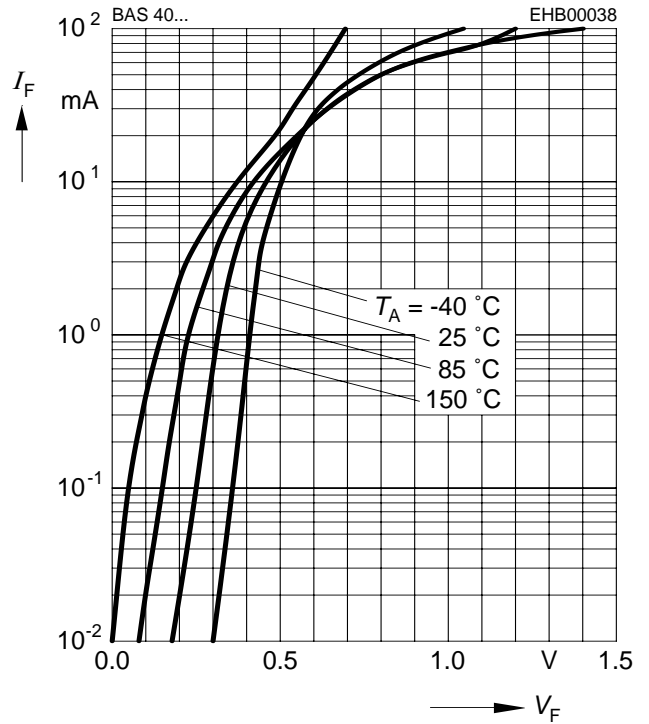

Forward current $I_F = f(T_S)$

BAS140W

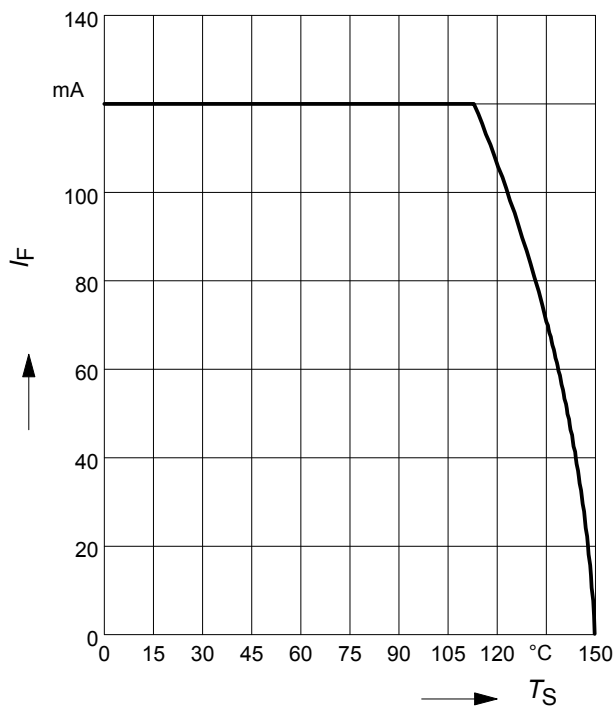

Forward current $I_F = f(T_S)$

BAS40, BAS40-07

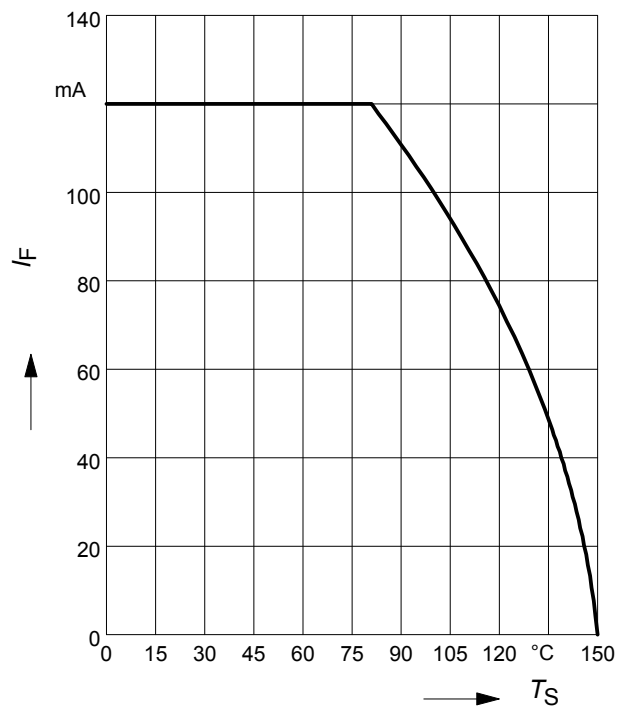

Forward current $I_F = f(T_S)$

BAS40-02L

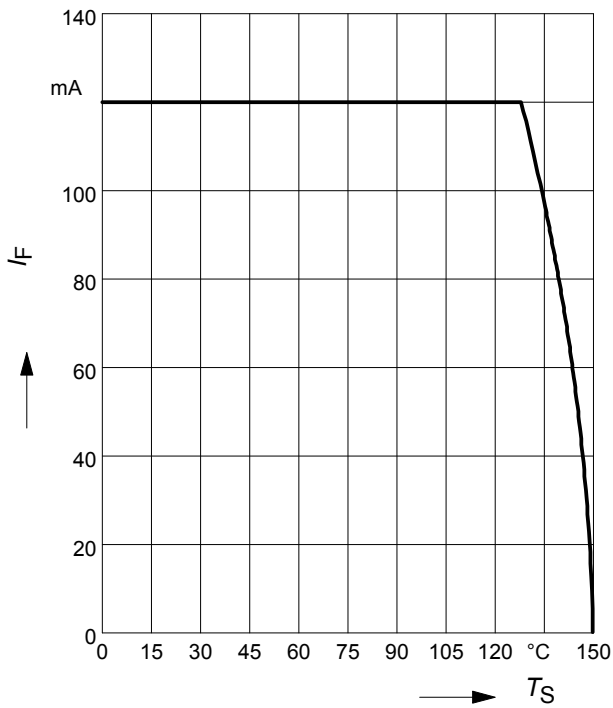

Forward current $I_F = f(T_S)$

BAS40-04, BAS40-06

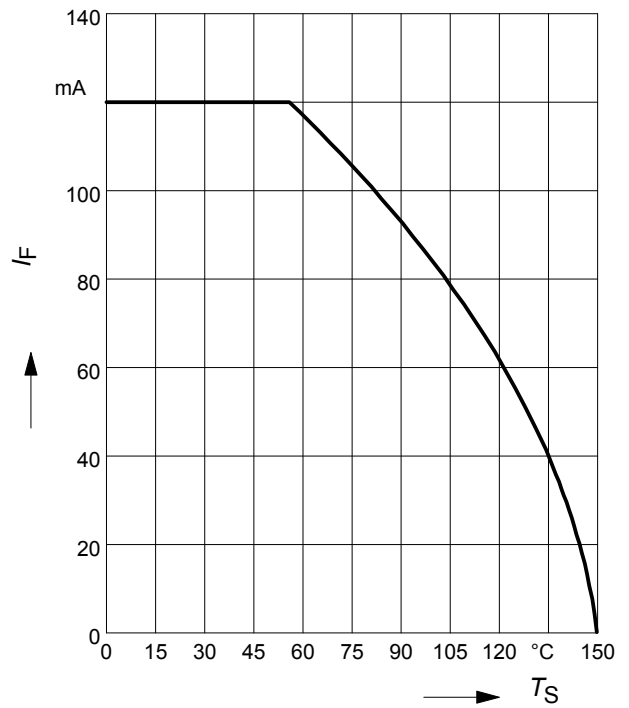

Forward current $I_F = f(T_S)$

BAS40-06W

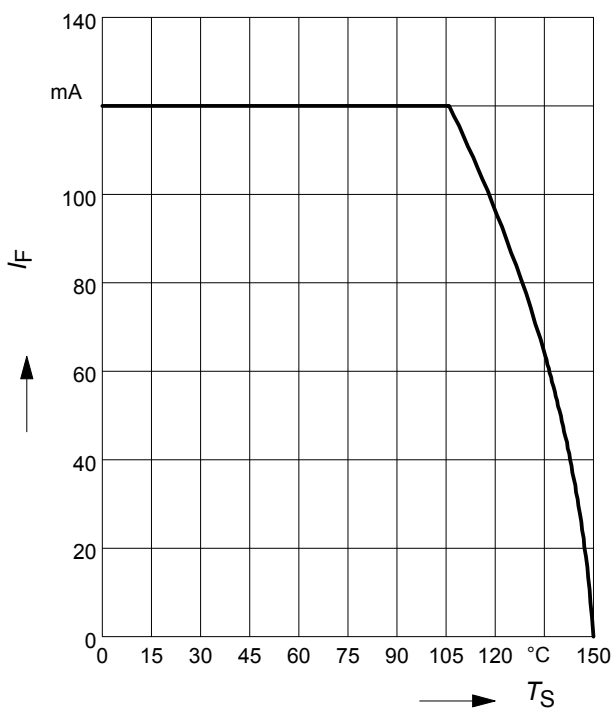

Forward current $I_F = f(T_S)$

BAS40-05

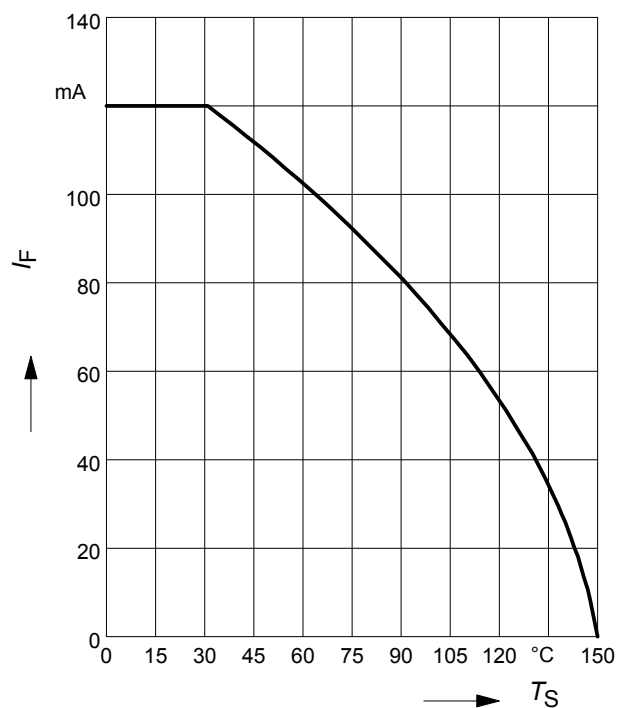

Forward current $I_F = f(T_S)$

BAS40-05W

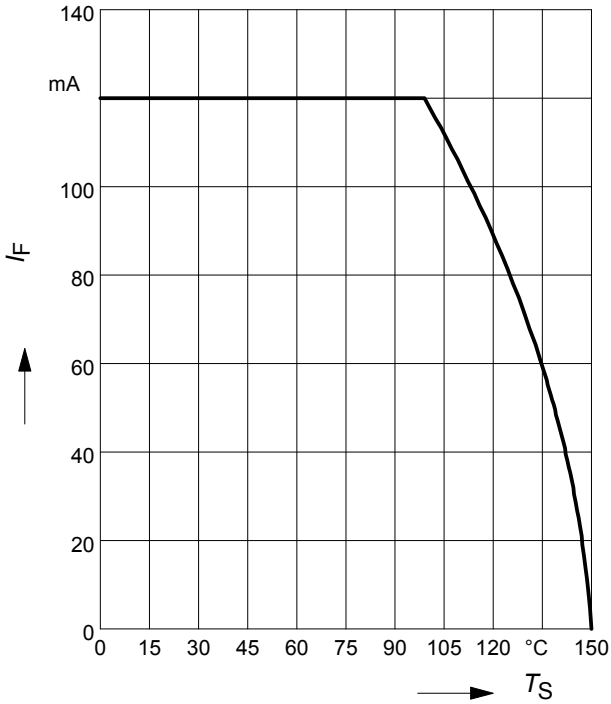

Forward current $I_F = f(T_S)$

BAS40-07W

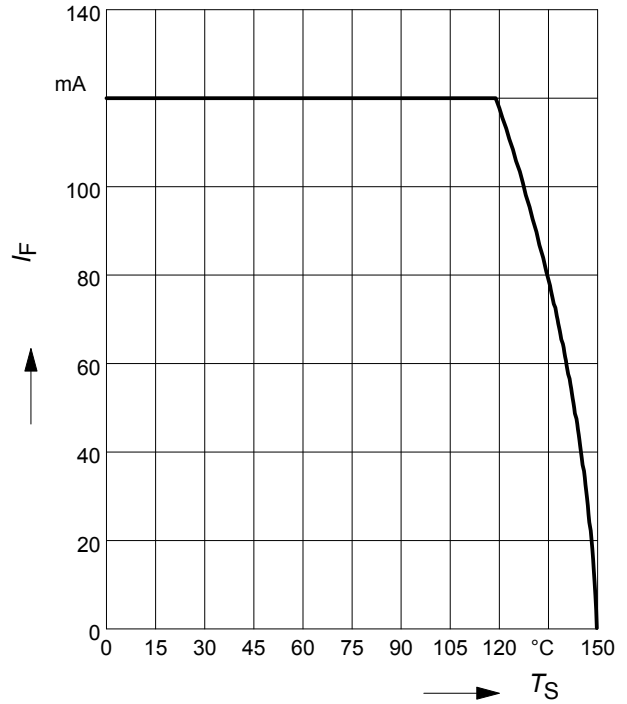

Permissible Puls Load $R_{thJS} = f(t_p)$

BAS140W

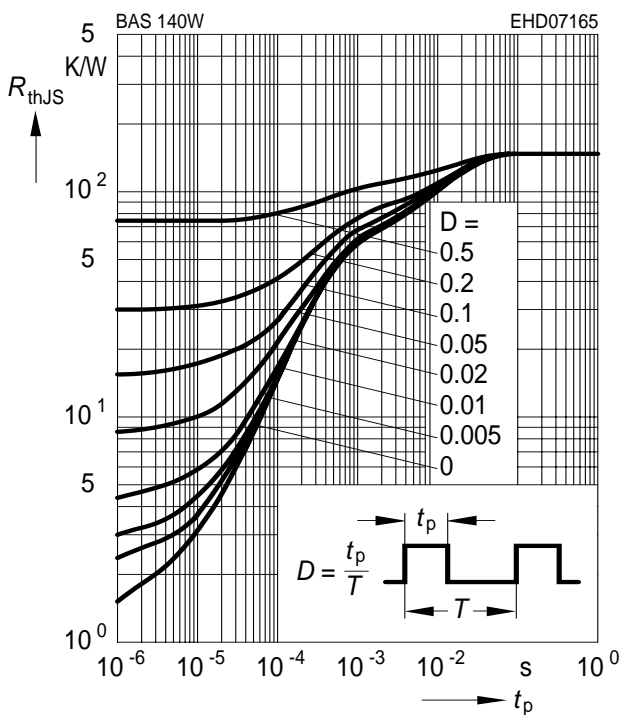

Permissible Pulse Load

$I_{Fmax} / I_{FDC} = f(t_p)$

BAS140W

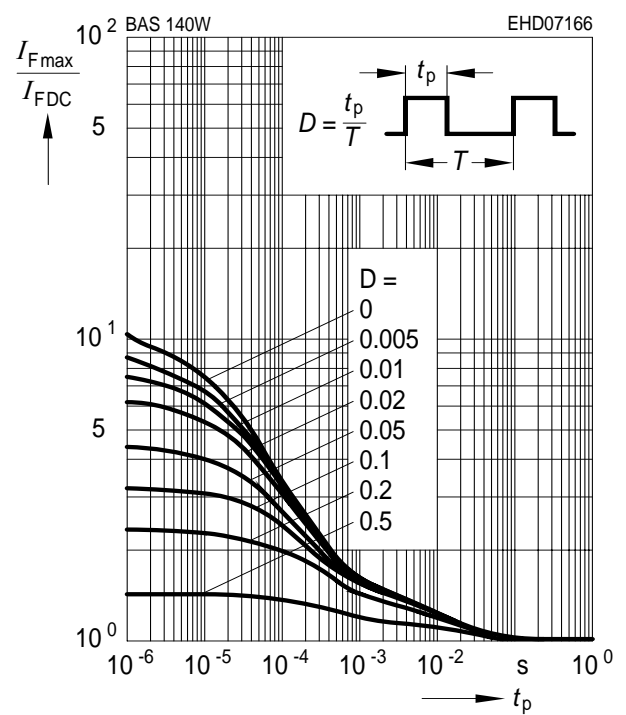

Permissible Puls Load $R_{thJS} = f(t_p)$

BAS40-02L

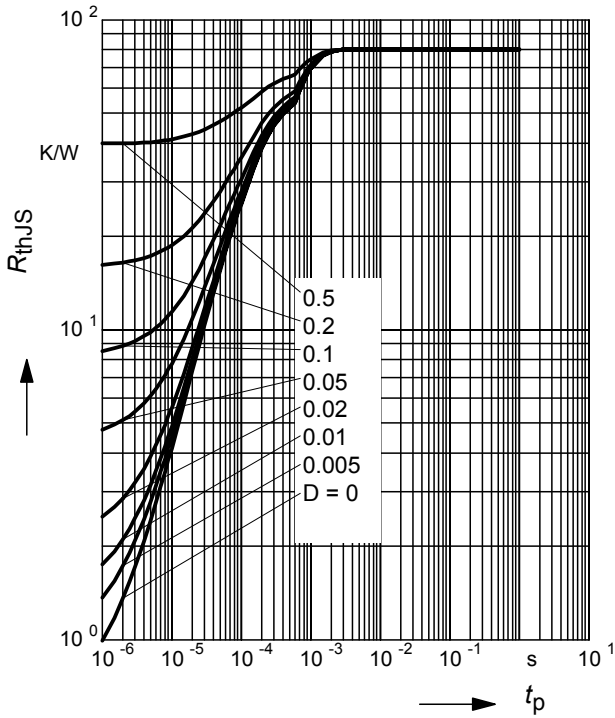

Permissible Pulse Load

$I_{Fmax} / I_{FDC} = f(t_p)$

BAS40-02L

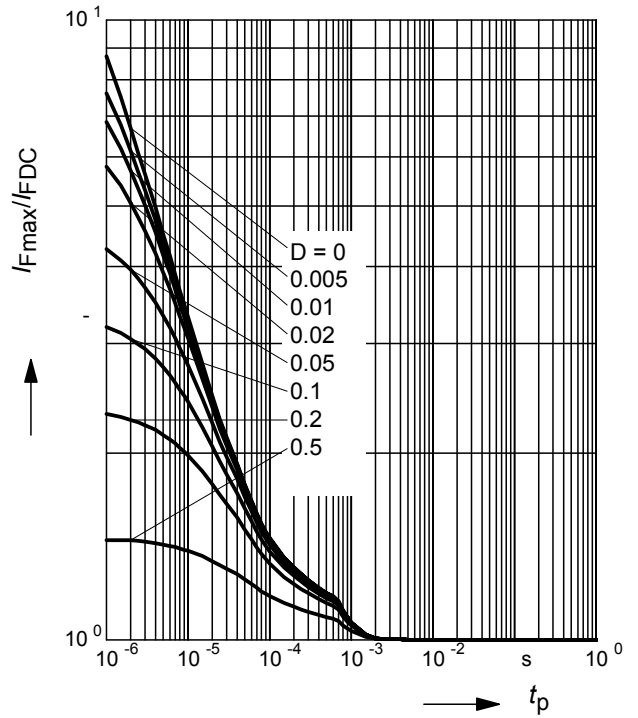

Permissible Puls Load $R_{thJS} = f(t_p)$

BAS40-06W

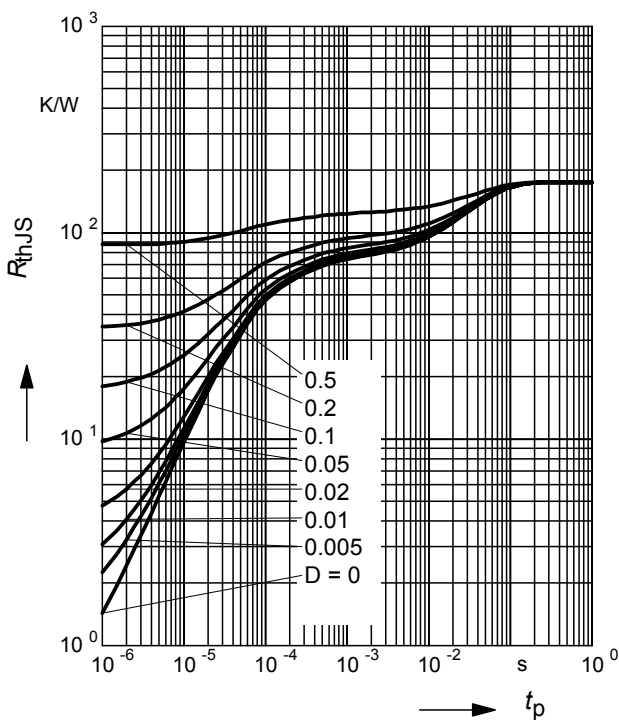

Permissible Pulse Load

$I_{Fmax} / I_{FDC} = f(t_p)$

BAS40-06W

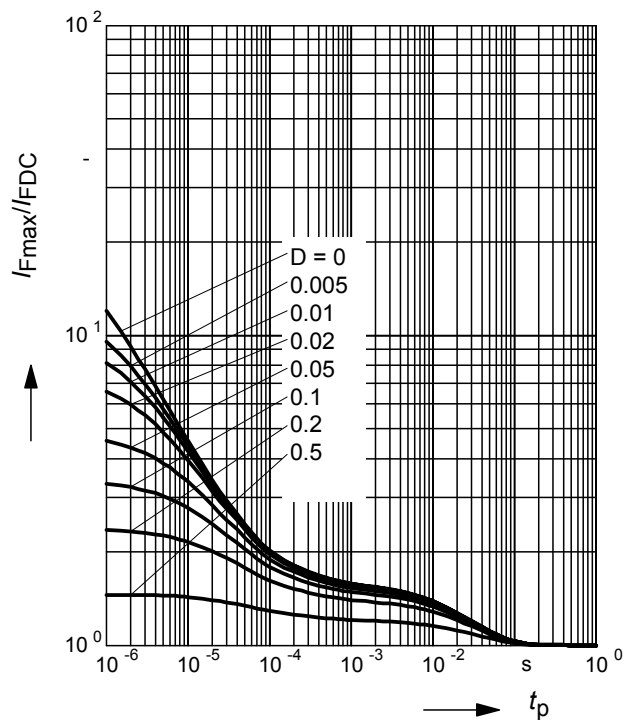

Permissible Puls Load $R_{thJS} = f(t_p)$

BAS40-05W

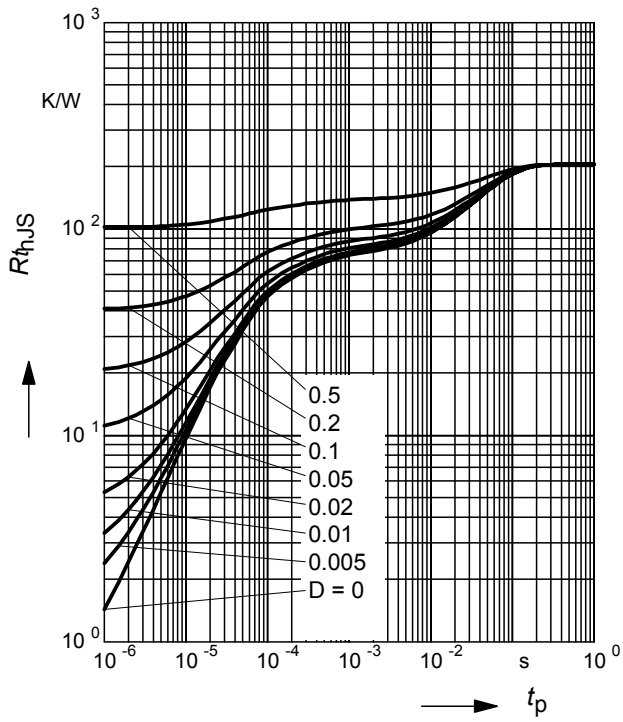

Permissible Pulse Load

$I_{Fmax} / I_{FDC} = f(t_p)$

BAS40-05W

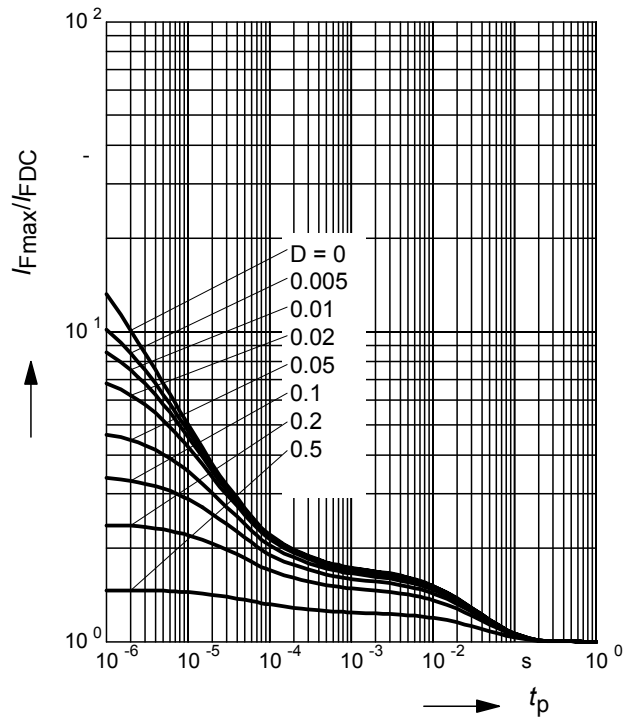

Package Outline

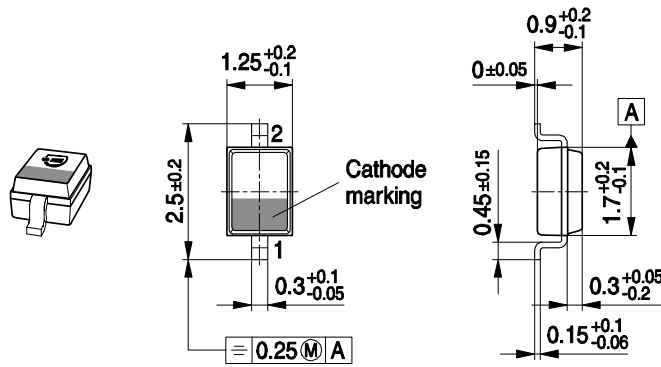

Foot Print

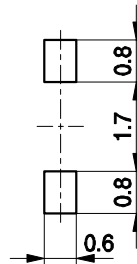

Marking Layout (Example)

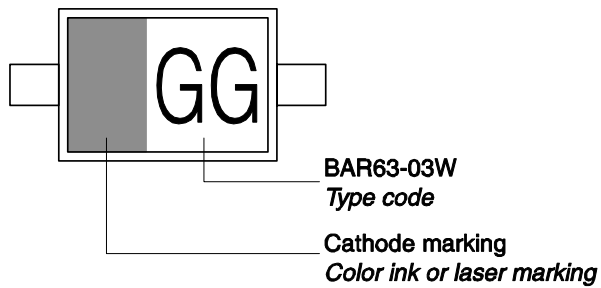

Standard Packing

Reel ø180 mm = 3.000 Pieces/Reel
 Reel ø330 mm = 10.000 Pieces/Reel

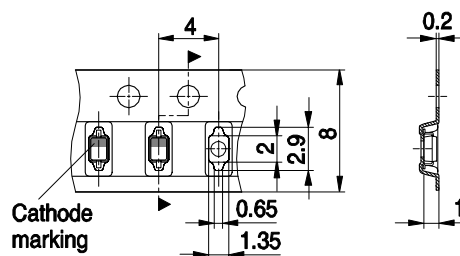

Package Outline

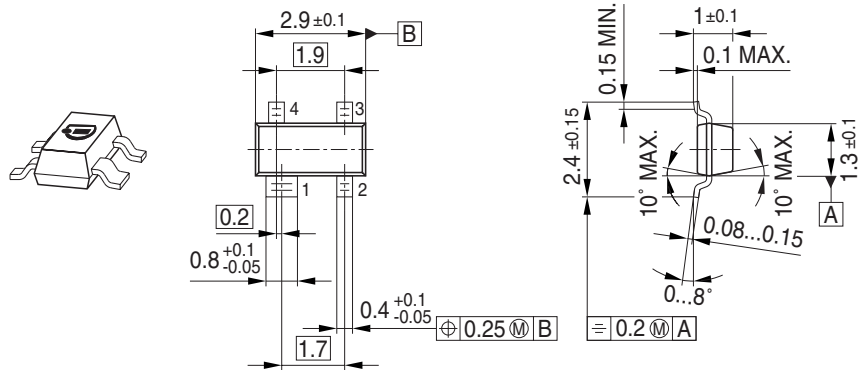

Foot Print

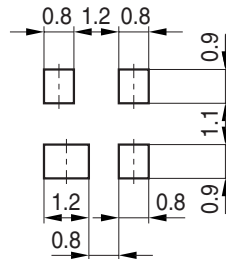

Marking Layout (Example)

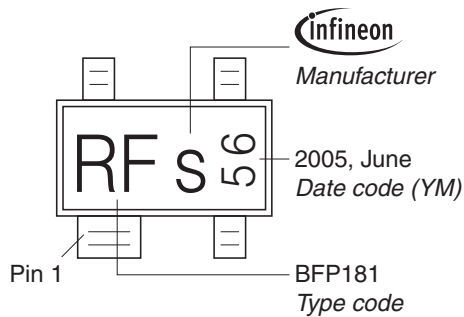

Standard Packing

Reel ϕ 180 mm = 3.000 Pieces/Reel
 Reel ϕ 330 mm = 10.000 Pieces/Reel

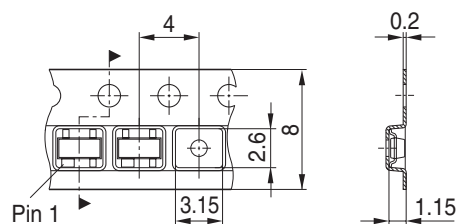

Package Outline



1) Lead width can be 0.6 max. in dambar area

Foot Print

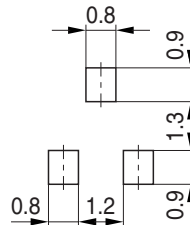

Marking Layout (Example)



Standard Packing

Reel \varnothing 180 mm = 3.000 Pieces/Reel
 Reel \varnothing 330 mm = 10.000 Pieces/Reel

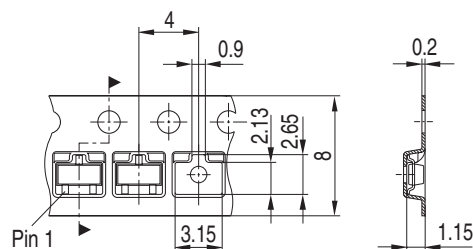

Package Outline

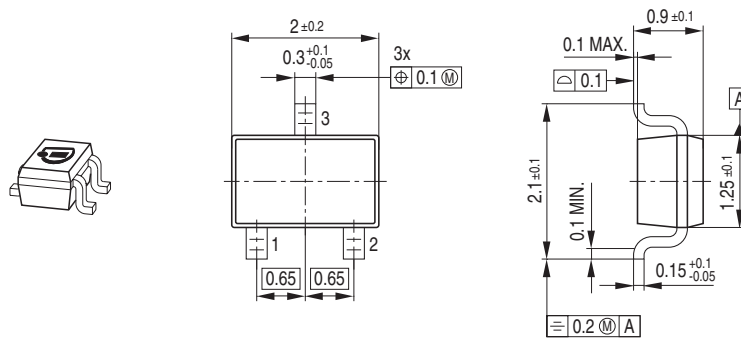

Foot Print

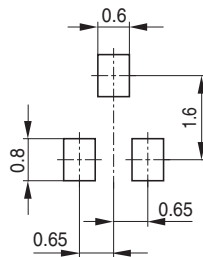

Marking Layout (Example)

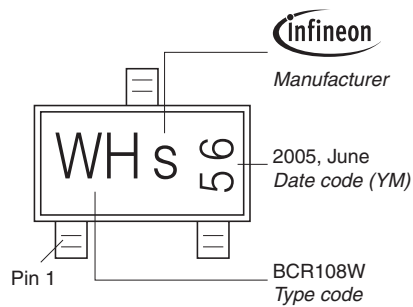

Standard Packing

Reel ø180 mm = 3.000 Pieces/Reel
 Reel ø330 mm = 10.000 Pieces/Reel

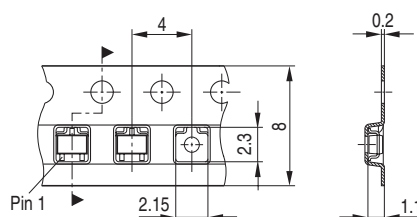

Package Outline

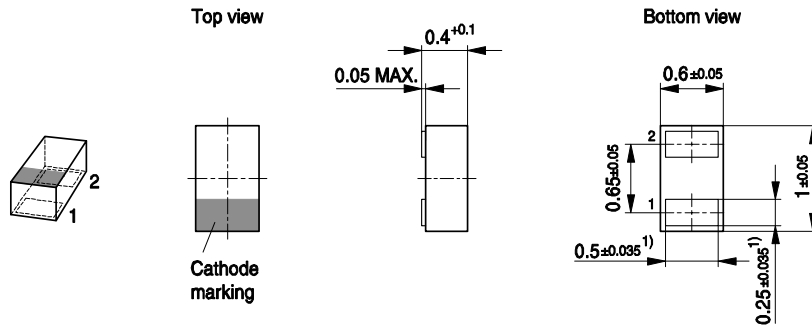

1) Dimension applies to plated terminal

Foot Print

For board assembly information please refer to Infineon website "Packages"

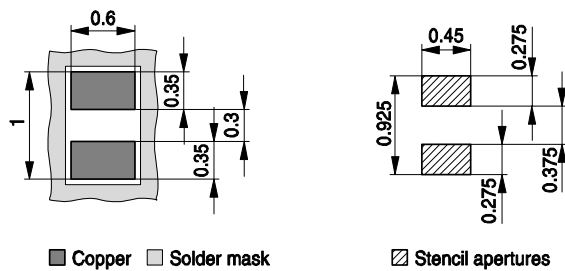

Marking Layout (Example)

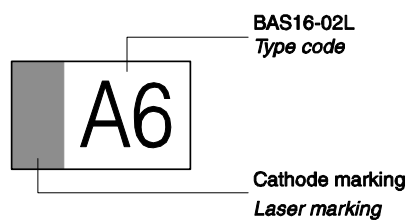

Standard Packing

Reel \varnothing 180 mm = 15.000 Pieces/Reel
 Reel \varnothing 330 mm = 50.000 Pieces/Reel (optional)

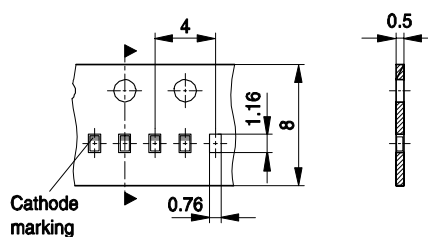

Edition 2009-11-16

**Published by
Infineon Technologies AG
81726 Munich, Germany**

**© 2009 Infineon Technologies AG
All Rights Reserved.**

Legal Disclaimer

The information given in this document shall in no event be regarded as a guarantee of conditions or characteristics. With respect to any examples or hints given herein, any typical values stated herein and/or any information regarding the application of the device, Infineon Technologies hereby disclaims any and all warranties and liabilities of any kind, including without limitation, warranties of non-infringement of intellectual property rights of any third party.

Information

For further information on technology, delivery terms and conditions and prices, please contact the nearest Infineon Technologies Office ([<www.infineon.com>](http://www.infineon.com)).

Warnings

Due to technical requirements, components may contain dangerous substances. For information on the types in question, please contact the nearest Infineon Technologies Office.

Infineon Technologies components may be used in life-support devices or systems only with the express written approval of Infineon Technologies, if a failure of such components can reasonably be expected to cause the failure of that life-support device or system or to affect the safety or effectiveness of that device or system. Life support devices or systems are intended to be implanted in the human body or to support and/or maintain and sustain and/or protect human life. If they fail, it is reasonable to assume that the health of the user or other persons may be endangered.

Компания «Океан Электроники» предлагает заключение долгосрочных отношений при поставках импортных электронных компонентов на взаимовыгодных условиях!

Наши преимущества:

- Поставка оригинальных импортных электронных компонентов напрямую с производств Америки, Европы и Азии, а так же с крупнейших складов мира;
- Широкая линейка поставок активных и пассивных импортных электронных компонентов (более 30 млн. наименований);
- Поставка сложных, дефицитных, либо снятых с производства позиций;
- Оперативные сроки поставки под заказ (от 5 рабочих дней);
- Экспресс доставка в любую точку России;
- Помощь Конструкторского Отдела и консультации квалифицированных инженеров;
- Техническая поддержка проекта, помощь в подборе аналогов, поставка прототипов;
- Поставка электронных компонентов под контролем ВП;
- Система менеджмента качества сертифицирована по Международному стандарту ISO 9001;
- При необходимости вся продукция военного и аэрокосмического назначения проходит испытания и сертификацию в лаборатории (по согласованию с заказчиком);
- Поставка специализированных компонентов военного и аэрокосмического уровня качества (Xilinx, Altera, Analog Devices, Intersil, Interpoint, Microsemi, Actel, Aeroflex, Peregrine, VPT, Syfer, Eurofarad, Texas Instruments, MS Kennedy, Miteq, Cobham, E2V, MA-COM, Hittite, Mini-Circuits, General Dynamics и др.);

Компания «Океан Электроники» является официальным дистрибьютором и эксклюзивным представителем в России одного из крупнейших производителей разъемов военного и аэрокосмического назначения «JONHON», а так же официальным дистрибьютором и эксклюзивным представителем в России производителя высокотехнологичных и надежных решений для передачи СВЧ сигналов «FORSTAR».



JONHON

«JONHON» (основан в 1970 г.)

Разъемы специального, военного и аэрокосмического назначения:

(Применяются в военной, авиационной, аэрокосмической, морской, железнодорожной, горно- и нефтедобывающей отраслях промышленности)

«FORSTAR» (основан в 1998 г.)

ВЧ соединители, коаксиальные кабели, кабельные сборки и микроволновые компоненты:

(Применяются в телекоммуникациях гражданского и специального назначения, в средствах связи, РЛС, а так же военной, авиационной и аэрокосмической отраслях промышленности).



Телефон: 8 (812) 309-75-97 (многоканальный)

Факс: 8 (812) 320-03-32

Электронная почта: ocean@oceanchips.ru

Web: <http://oceanchips.ru/>

Адрес: 198099, г. Санкт-Петербург, ул. Калинина, д. 2, корп. 4, лит. А